



Series SX502

Alphanumeric large size displays
with Modbus/TCP interface

Operating instructions

1 Contact

www.siebert-group.com

GERMANY

Siebert Industrieelektronik GmbH
Siebertstrasse, D-66571 Eppelborn
P.O. Box 11 30, D-66565 Eppelborn
Phone +49 (0)6806 980-0, Fax +49 (0)6806 980-999
email: info.de@siebert-group.com

AUSTRIA

Siebert Österreich GmbH
Mooslackengasse 17, A-1190 Wien
Phone +43 (0)1 890 63 86-0, Fax +43 (0)1 890 63 86-99
email: info.at@siebert-group.com

FRANCE

Siebert France Sarl
4 rue de l'Abbé Louis Verdet, F-57200 Sarreguemines
P.O. Box 90 334, F-57203 Sarreguemines Cédex
Phone +33 (0)3 87 98 63 68, Fax +33 (0)3 87 98 63 94
email: info.fr@siebert-group.com

ITALY

Siebert Italia Srl
Via Galileo Galilei 2A, I-39100 Bolzano (BZ)
Phone +39 (0)471 053753 Fax +39 (0)471 053754
email info.it@siebert-group.com

THE NETHERLANDS

Siebert Nederland B.V.
Jadedreef 26, NL-7828 BH Emmen
Phone +31 (0)591-633444, Fax +31 (0)591-633125
email: info.nl@siebert-group.com

SWITZERLAND

Siebert AG
Bützbergstrasse 2, CH-4912 Aarwangen
Phone +41 (0)62 922 18 70, Fax +41 (0)62 922 33 37
email: info.ch@siebert-group.com

2 Legal note

© Siebert Industrieelektronik GmbH

This operation manual has been prepared with the utmost care. However, we do not accept any liability for possible errors. We always appreciate your suggestions for improvement, corrections, comments and proposals. Please contact us: editing@siebert-group.com

Siebert[®], LRD[®] and XC-Board[®] are registered trademarks of Siebert Industrieelektronik GmbH. All other product names mentioned herein may be trademarks or registered trademarks of their respective owners.

We reserve the right to make alterations to the technical data and delivery options without notice. - All rights reserved, including the rights of translation. No part of this document may in any form or by any means (print, photocopy, microfilm or any other process) be reproduced or by using electronic systems be processed, copied or distributed without our written permission.

Table of contents

1 Contact	2
2 Legal note	3
3 Safety precautions	7
Important information	7
Safety	7
Intended use.....	7
Mounting and installation.....	7
Grounding.....	8
EMC measures.....	8
Disposal.....	8
4 Unit description	9
Model designation	9
Unit construction.....	9
Principle circuit diagram	10
Central Processing Unit.....	11
Ethernet interface	11
Serial Interface	11
Function inputs	12
Menu display	12
Menu buttons.....	12
Battery	12
Power supply.....	12
5 Character display	13
LED matrix.....	13
Character display.....	13
Character sets	13
Multi-line units.....	14
Character height.....	15
Proportional lettering	15
LED color.....	15
6 Control	16
Function code.....	16
Start address	16
Data transmission.....	16
Text types	16
Commands	16
Display dynamic text	18

Static texts	18
Inserting variables	18
Deleting text.....	19
Forced line break.....	19
Flashing	19
Marquee text.....	19
Character set.....	19
LED color	20
Inserting time/date	20
Bar graph.....	20
Character \$.....	20
Brightness.....	20
Reset	20
Setting time/date.....	20
Reading out time/date	20
Paging	21
Initial text	21
7 Individual line selection	22
Application	22
Commands	22
Display dynamic text	23
Display static text.....	23
Insert variables	23
Deleting text.....	23
Flashing	23
Line numbers.....	23
8 Parameterization	25
Menu.....	25
Menu operation.....	25
Menu table.....	25
Time-out	28
Initial text	28
Paging	28
Character set.....	28
Language.....	28
Display test.....	28
Network parameters	28
Set time/date	28
9 Status messages	30

Fault messages	30
10 Character table	31
11 Technical data	32
Unit properties	32
Housing colors	33
Front frame	33
Ambient conditions	33
Max. power consumption	33
Screw-type terminals	34
Fixed text memory	34
Marquee	34
Real-time clock	34
Dimensions and weights	35

3 Safety precautions



Bus errors may result in personal injury or material damage. Therefore it must be noted that the reset of the display with command \$0 and activation of the menu may cause a bus error.

Important information

Read these operating instructions before starting the unit. They provide you with important information on the use, safety and maintenance of the units. This helps you to protect yourself and prevent damage to the unit.



Information intended to help you to avoid death, bodily harm or considerable damage to property is highlighted by the warning triangle shown here; it is imperative that this information be properly heeded.

The operating instructions are intended for trained professional electricians familiar with the safety standards of electrical technology and industrial electronics.

Store these operating instructions in an appropriate place.

The manufacturer is not liable if the information in these operating instructions is not complied with.

Safety



Components inside the units are energized with electricity during operation. For this reason, mounting and maintenance work may only be performed by professionally-trained personnel while observing the corresponding safety regulations.

The repair and replacement of components and modules may only be carried out by the manufacturer for safety reasons and due to the required compliance with the documented unit properties.

The units do not have a power switch. They are operative as soon as the operating voltage is applied.

Intended use

The units are intended for use in industrial environments. They may only be operated within the limit values stipulated by the technical data.

When configuring, installing, maintaining and testing the units, the safety and accident-prevention regulations relevant to use in each individual case must be complied with.

Trouble-free, safe operation of the units requires proper transport, storage, installation, mounting and careful operation and maintenance of the units.

Mounting and installation

The attachment options for the units were conceived in such a way as to ensure safe, reliable mounting.



The user must ensure that the attachment hardware, the unit carrier and the anchoring at the unit carrier are sufficient to securely support the unit under the given surrounding conditions.

The units are to be mounted in such a way that they can be opened up while mounted. Sufficient space for the cables must be available in the unit near the cable entries.

Sufficient space is to be kept clear around the units to ensure air circulation and to prevent the build-up of heat resulting from use. The relevant information must be heeded in the case of units ventilated by other means.



When the housing fasteners are opened, the front frame of the housing hinges out upward or downward (depending on the unit version) automatically.

Grounding

All devices are equipped with a metal housing. They comply with safety class I and require a protective earth connection. The connecting cable for the operating voltage must contain a protective earth wire of a sufficient cross section (DIN VDE 0106 part 1, DIN VDE 0411 part 1).

EMC measures

The devices comply with the current EU Directive (EMC Directive) and provide the required interference immunity. Observe the following when connecting the operating voltage and data cables:

Use shielded data cables.

The data and operating voltage cables must be laid separately. They may not be laid together with heavy-current cables or other interference-producing cables.

The cable thickness must be properly assessed (DIN VDE 0100 Part 540).

The cable lengths inside the units are to be kept as short as possible to prevent interference. This applies especially to unshielded operating voltage cables. Shielded cables are also to be kept short due to any interference which might be emitted by the shielding.

Neither excessively long cables nor cable loops may be placed inside the units.

The connection of the cable shielding to the functional ground (PE) must be as short and low-impedance as possible. It should be made directly to the mounting plate over a large area with a conductive clip:

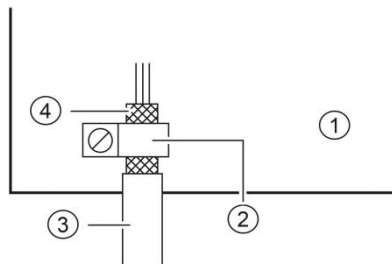

- | | |
|------------------|--------------------|
| ① mounting plate | ② conductive clamp |
| ③ data lines | ④ cable shielding |

The cable shielding is to be connected at both cable ends. If equipotential bonding currents are expected due to the cable arrangement, electrical isolation is to be performed on one side. In this case, capacitive connection (approx. $0.1\mu\text{F}/600\text{ V AC}$) of the shielding on the isolated side must occur.

Disposal

Units or unit parts which are no longer needed are to be disposed of in accordance with the regulations in effect in your country.

4 Unit description

Model designation

This manual applies to units with the following model designation (x = the 'x's in the model designation indicate the size and design of the units):

SX502-xxx/xx/xx-xxx/xx-CT

Unit construction

The following figure shows model type SX502-220/05/xx-xxx/xx-xx as example for the other model types. The front frame of the housing is locked with quick-action releases. When opening the unit the front frame hinges downward (exceptions to this are SX502-640/05/xx-xxx/xx-xx and SX502-840/05/xx-xxx/xx-xx: which open upward supported by gas-pressure springs).

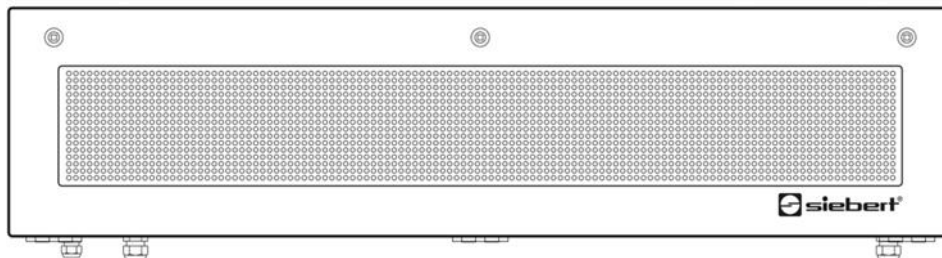

The following figure shows the unit when open.

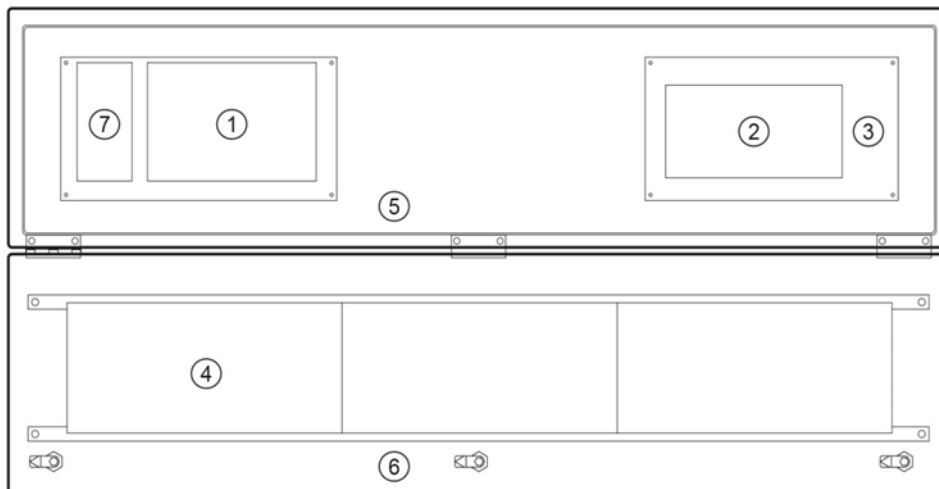

- | | | |
|---------------------------|-------------------------|-----------------------------------|
| ① Central Processing Unit | ② Power supply unit | ③ Connector plug for power supply |
| ④ Matrix modules | ⑤ Lower housing section | ⑥ Housing front frame |
| ⑦ Gateway | | |

Units with double-sided display show the same information on the front and on the rear side.

Principle circuit diagram

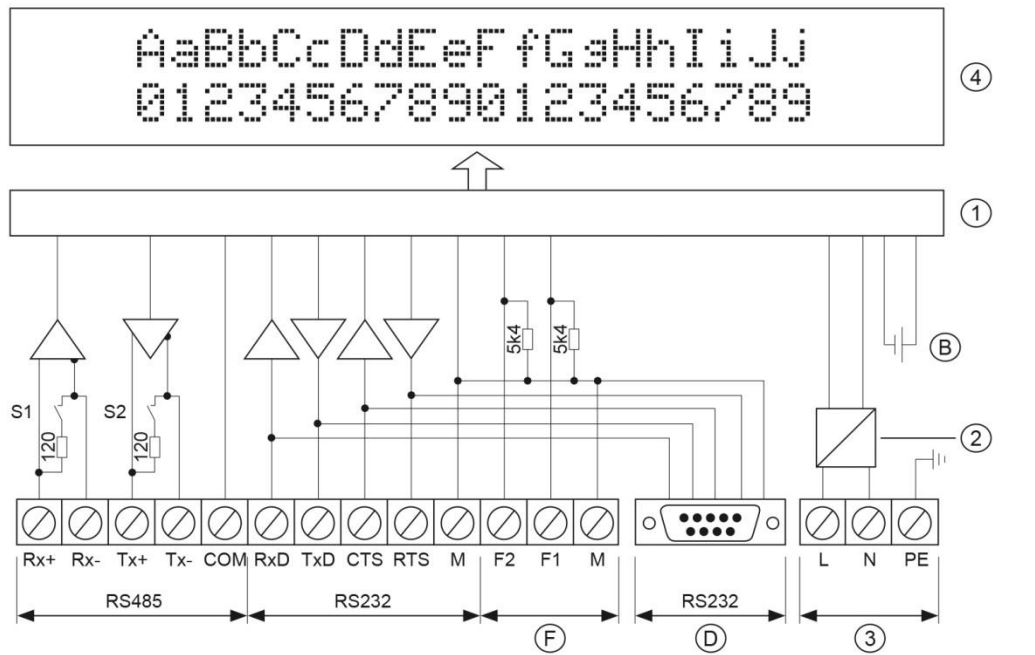

- ① Central Processing Unit
- ② Power supply unit
- ③ Power supply
- ④ Display
- Ⓑ Battery
- Ⓓ Sub D connector – serial interface
- Ⓕ Function input

Central Processing Unit

The following figure shows the Central Processing Unit, located in the lower part of the housing.

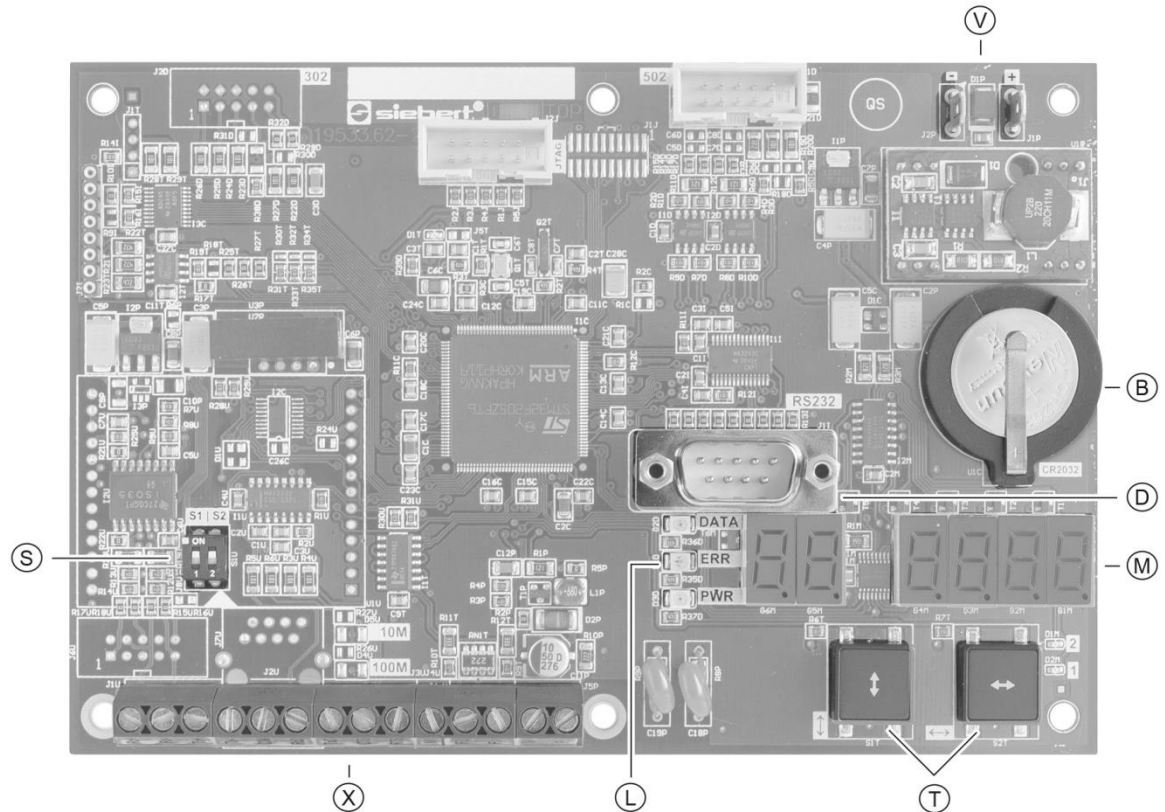

- | | | |
|----------------|--------------------------------------|--------------------|
| ⓑ Battery | ⓓ Sub D connector - serial interface | Ⓛ Status indicator |
| Ⓜ Menu display | Ⓢ Switchable bus termination | Ⓣ Menu buttons |
| Ⓥ Power supply | Ⓧ Screw-type terminal switch | |

Ethernet interface

The Ethernet interface is located on a standard RJ45 socket on the gateway. It has the following specifications:

Data rate 10/100 Mbp/s, automatic detection

Galvanic isolation 1.5 kV

Supported protocols Modbus TCP, DHCP

Operation modes The units are TCP Slaves *according to the Open Modbus / TCP Specification, Release 1.0.*

For the Modbus/TCP communication the TCP Port no. 502 is used.

Configuration The IP address is set via an additionally included software tool.

Serial Interface

The interface RS232 is determined for programming the device using a PC, for example for loading static texts in the text memory and for installing character sets by means of the PC tools 'DisplayManager' and 'FontManager' provided on data carrier.

The interface RS232 is located, on the sub D connector of the control computer. It has the following assignment:

Pin	1	2	3	4	5	6	7	8	9
Signal	–	RxD	TxD	–	COM	–	RTS	CTS	–

The PC connection is established using a standard null-modem cable.

The parameters of the interface are as follows: 9600 bauds, 8 data bits, no parity, 1 stop bit, RTS/CTS handshake, CR/LF protocol, no addressing.

Function inputs

The function inputs are located on the screw-type terminal strip of the control computer. They allow reduction in brightness and flashing of the display, independently of commands via the Modbus/TCP interface.

The function inputs are designed for the following signal voltages:

Signal voltage: L = -3.5...+5 V (open input = L)
 H = +18...30 V (active H), M = reference potential

Menu display

The parameterization of the units is carried out in a menu of the menu display.

In normal operation, the following status messages can appear in the menu display:

on L inE Data are received at the interface
dRtR Device detects a telegram ending
rdLE Device is ready and waiting for data

In programming mode, the following status messages can appear in the menu display:

PrOG The device is in programming operation
L oAd Static texts are loaded in the text memory
rERd Static texts are read from the text memory

Menu buttons

The menu buttons are used to control the menu.

Battery

The lithium battery (type CR2032) provides a power reserve for the real-time clock. It is located in a battery holder and should be replaced after three years.

Power supply

The screw-type terminals for the power supply are located on the power supply unit in the bottom section of the housing. They have the following designations:

Devices for a power supply 115 V AC or 230 V AC L, N and PE
 Devices for a power supply 24 V DC +, – and PE

5 Character display

LED matrix

The characters are displayed on an LED matrix. A matrix module is 16 LED dots (pixels) high and, depending on the unit version, the following number of pixels wide:

Unit versions SX502-x20/xx/xx-xxx/xx-xx:	120 pixels
Unit versions SX502-x40/xx/xx-xxx/xx-xx:	240 pixels

Character display

The units feature several different character sets, which will be elaborated on later. The following explanation is based on the Acala 7 character set.

With this character set, the character width is five pixels and the space between characters is one pixel. Units with a 120 pixel-wide matrix can therefore display 20 characters on a line and units with a 240 pixel-wide matrix can display 40 characters on a line.

The character height is seven pixels. Thus two lines of seven pixel-high characters with a space between lines of two pixels can be displayed on a 16 pixel-high matrix module.

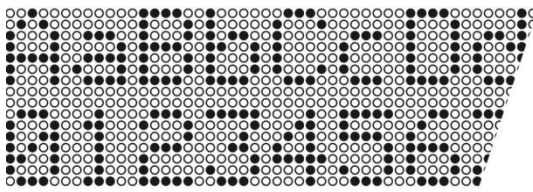

This means that two lines of 20 characters each can be displayed on a 120 x 16 pixel matrix and two lines of 40 characters each can be displayed on a 240 x 16 pixel matrix.

If the entire height of the matrix is used, characters with twice the character height, i.e. 14 pixels, can be displayed. The Acala 14 condensed character set, for example, is available for this. It uses a height of 14 pixels out of the 16 pixels available in the matrix.

With this character set, the character width is eight pixels and the space between characters is two pixels. Ten pixels are thus required for the width of each character. According to this, units with a 120 pixel-wide matrix can therefore display one line with 12 characters and units with a 240 pixel-wide matrix can display one line with 24 characters.

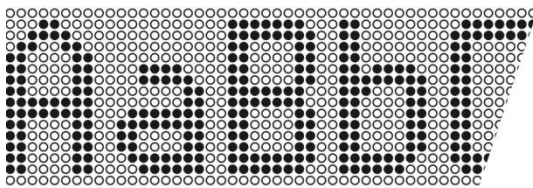

Character sets

The following pictured character sets are available. They differ in character height (seven, 14 or 16 pixels) and in character width (normal, extended or condensed).

The number of characters (number of lines x number of characters per line) which can be displayed on a 120 x 16 and 240 x 16 pixel matrix for each character set is noted in the table.

Character set	Character display	120 x 16 pixels	240 x 16 pixels
Acala 7*	AaBbCcDdEeFfGgHhIiJj AaBbCcDdEeFfGgHhIiJj	2 x 20	2 x 40
Acala 7 extended*	AaBbCcDdEeEe AaBbCcDdEeEe	2 x 10	2 x 20
Acala 14 condensed*	AaBbCcDdEeFf	1 x 12	1 x 24
Acala 14	AaBbCcDdEe	1 x 10	1 x 20
Acala 14 extended*	AaBcDd	1 x 6	1 x 12
Acala 16 condensed	AaBbCcDdEeFf	1 x 12	1 x 24
Acala 16	AaBbCcDdEe	1 x 10	1 x 20
Acala 16 extended	AaBbCc	1 x 6	1 x 12

The character sets marked with * in the table are permanently installed in the units. The remaining character sets are included on a data carrier.

The PC tool 'DisplayManager' that can also be found on the included data carrier is used for installing character sets, for creating user-defined character sets, for saving character sets on data carriers and for restoring the installed character sets.

Multi-line units

To display texts containing more characters than can be displayed with a 120 x 16 or 240 x 16 pixel matrix we offer unit versions with a suitable number of matrix modules arranged vertically.

The following figure shows unit version SX502-420/05/xx-xxx/xx-xx with two vertically arranged 120 x 16 pixel matrix modules as an example. Character set Acala 7 allows 4 x 20 characters to be displayed, and 2 x 12 characters can be displayed with the character set Acala 14 condensed.

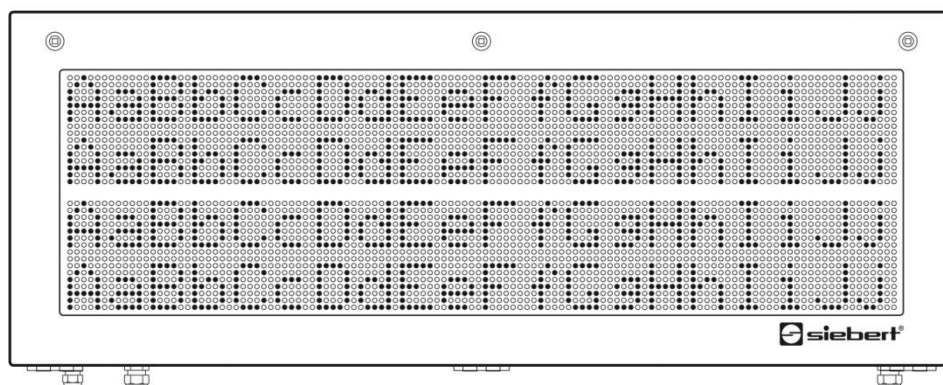

The physical distance between the matrix modules corresponds to a height of two pixels. Thus the distance between the first and second lines is the same as between the second and third lines.

The SX502 series also includes units with three or four vertically arranged matrix modules. They can display six or eight lines with the Acala 7 character set and three or four lines with the Acala 14 condensed character set.

Character height

The actual character height depends on the height of a character in pixels and the size of the pixel diameter and spacing.

The SX502-xxx/03/xx-xxx/xx-xx unit versions have a pixel diameter of approx. 3 mm and a pixel spacing of approx. 4.7 mm.

The SX502-xxx/05/xx-xxx/xx-xx unit versions have a pixel diameter of approx. 5 mm and a pixel spacing of approx. 7.6 mm.

This results in the following actual character heights for the character sets, depending on the unit version:

Character set	SX502-xxx/03/xx-xxx/xx-xx	SX502-xxx/05/xx-xxx/xx-xx
Acala 7	approx. 33 mm	approx. 50 mm
Acala 7 extended	approx. 33 mm	approx. 50 mm
Acala 14 condensed	approx. 66 mm	approx. 100 mm
Acala 14	approx. 66 mm	approx. 100 mm
Acala 14 extended	approx. 66 mm	approx. 100 mm
Acala 16 condensed	approx. 75 mm	approx. 120 mm
Acala 16	approx. 75 mm	approx. 120 mm
Acala 16 extended	approx. 75 mm	approx. 120 mm

Proportional lettering

The previously described character sets display the characters in non-proportional lettering (monospace font). The same number of pixels is available for the width of each character.

Character sets Acala 7 P and Acala 14 P, which display the characters in proportional lettering, are included on data carrier. Each character uses the width it requires visually.

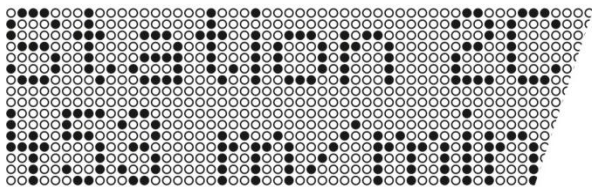

LED color

The unit versions SX502-xxx/xx/xR-xxx/xx-xx have a display with red LED color. The LED color cannot be changed (monochrome display).

The unit versions SX502-xxx/xx/xM-xxx/xx-xx have a display whose LED color can be switched between red, green and orange.

6 Control

Function code

The devices are Modbus TCP slaves according to the *Open/ Modbus/TCP Specification, Release 1.0*. They support function code 16 (0x10) Write Multiple registers.

The indications in the above mentioned documentation are to be observed.

Start address

As start address register address 0000_h is to be used.

Data transmission

Data is transmitted with up to 200 bytes per frame. Since the sum of all bytes in the Modbus must be an even number with an odd number of data bytes in the data telegram you have to paste a dummy byte with the value 0x00 behind the telegram ending.

In each Modbus frame you can only transmit one data telegram.

If the pack of data is more than 200 bytes the data telegram can be distributed over several Modbus frames. The end of a telegram must be marked by a telegram ending.

Text types

The devices can display dynamic and static texts.

Dynamic texts can be changed while the unit is running. They are generated from within the process and sent to the display as data telegram.

Static texts cannot be changed while the unit is running. They are compiled using the PC tool 'Text Manager' included on data carrier and loaded in the text memory via the serial interface. They can then be called up via their text number.

Commands

The control of the devices is done using commands according to the following command table. In the description, the numbers in [] refer to the corresponding lines in the command table.

Commands with ↵ require a telegram ending (<CR>, <LF> or <CR/LF>).

In lines [1] and [3] cc. . . stands for a character chain of any desired content.

Commands for text manipulations

Display dynamic text	cc . . . ↓	Send any desired characters	[1]
Display static text	\$Tn ↓	Calling up fixed text (n = text number, one to four digits)	[2]
Insert variables	\$VEcc . . . ↓	Entering variables from the current insertion position	[3]
	\$VPn ↓	Selecting insertion position of variables (n = wildcard number for the variable, 0...255)	[4]
Delete text	\$E ↓	Delete text in the display	[5]

Commands for text formatting

Line break	\$C	Forced line break	[6]
Flashing	\$F1	Flashing of following characters on	[7]
	\$F0	Flashing of following characters off	[8]
Marquee text	\$Y	Marquee text from current position until end of text or \$C	[9]
Charcter set	\$M1	Acala 7	[10]
	\$M2	Acala 7 extended	[11]
	\$M3	Acala 14 condensed	[12]
	\$M4	Acala 14 extended	[13]
	\$M5	Acala 7 P / user-defined character set 7 pixel	[14]
	\$M6	Acala 14 / user-defined character set 14/16 pixel	[15]
	\$M7	Acala 16 condensed	[15a]
	\$M8	Acala 16	[15b]
LED color	\$A0	Red	[16]
	\$A1	Green	[17]
	\$A2	Orange	[18]
Place holders for variables	\$VS	Inserting place holders for variables	[19]
Inserting time	\$HA	Current time (HH:MM:SS)	[20]
	\$HH	Hour of current time (HH)	[21]
	\$HM	Minute of current time (MM)	[22]
	\$HS	Second of current time (SS)	[23]
Inserting current date	\$DA	Current date, four-digit year (TT.MM.JJJJ)	[24]
	\$DB	Current date, two-digit year (TT.MM.JJ)	[25]
	\$DD	Current day (TT)	[26]
	\$DM	Current month (MM)	[27]
	\$DY	Current year, four-digit (JJJJ)	[28]
	\$DZ	Current year, two-digit (JJ)	[29]
	\$DW	Weekday in selected dialog language	[30]
Bar graph	\$Gnnnn	Bar graph display (nnn = number of columns, always enter in four numeric digits, e.g. \$G0040)	[31]

Character \$	\$\$	Display of the character '\$' in the text	[32]
--------------	------	---	------

Commands for display options

Flashing	\$F1↓	Flashing of the whole display on	[33]
	\$F0↓	Flashing of the whole display off	[34]
Brightness	\$B0↓	Normal brightness	[35]
	\$B1↓	Reduced brightness	[36]
Reset	\$0↓	Restart of the display	[37]

Commands for time and date

Set time/date	\$SHhmmss↓	Set time	[38]
	\$SDddmmyy↓	Set date	[39]
	\$SWx↓	Set weekday (x: 1 = Mon, 2 = Tue, 3 = Wed etc. till 7 = Sun)	[40]
Reading out time/date	\$RH↓	Read out time via Ethernet interface	[41]
	\$RD↓	Read out weekday and date via Ethernet interface	[42]

Display dynamic text

To display a dynamic text, its characters (cc...) are sent to the display as a data telegram [1]. Any text in the display is cleared when a new text is called up.

Static texts

Static texts are called up with the \$Tn↓ command and appear in the display. [2] n is the text number; it can be from one to four digits. Any text in the display is cleared when a static text is called up.

Inserting variables

This operating mode is used when the units are to display so-called text masks in which only certain characters are changed, e.g. for the updating of numerical values as in the following:

```
Temperature: 172 °C
Expansion : 243 mm
```

The text components *temperature*, *expansion*, °C and *mm* are fixed and do not change. The numerical values, on the other hand, are continually updated variable text components.

In principle, updating could occur with dynamic texts containing both the fixed and the variable text components. However, the data transfer required here is considerable.

The SX502 series offers the advantageous alternative of a one-time transmission of the fixed text components to the display and subsequent insertion of just the appropriate characters (variables) to update the variable text components. In the example shown above, the fixed text components of *temperature*, *expansion*, °C and *mm* are shown in the display with the following data telegram:

```
$M1temperature: $VS$VS$VS °C$Cexpansion: $VS$VS$VS mm↓
```

The place holders for variables to be inserted later are marked with the command \$VS [19]. They appear blank in the display. A variable corresponds to a character to be displayed. Up to 256 variables can be inserted into a text.

The place holder from which the variables are to be inserted in the text (insertion position) is marked with the command **\$VPn↓** [4]. n is the running number of the place holders for variables; it can be from one to three digits (0 – 255). In the example, the first insertion position is marked with the command **\$VP0↓**.

Insertion of the variables in the place holders occurs with the command **\$VEcc...↓** [3]. cc... stands for any character. In the example the variables are inserted with the data telegram **\$VE172243↓**. They can also be inserted in two steps with the data telegram **\$VE172↓** followed by **\$VE243↓**.

In the example, the fixed text components were shown in the display as dynamic text. Alternatively, they can be prepared as a fixed text called up from the text memory. The place holders for the variables are also to be marked with **\$VS** in the fixed text.

Deleting text

Any text in the display is cleared with the **\$E↓** command [5]. An LED dot then illuminates in the upper left-hand corner of the display.

Forced line break

If the text contains more characters than can be displayed in one line, a line break is inserted automatically at the end of the line, and the text is continued in the next line.

A line break can also be forced at a certain place in the text, for example for correct hyphenation [6] using the command **\$C**.

Flashing

The **\$F1** command in the data telegram causes the following characters to flash [7]. The **\$F0** command in the data telegram deactivates the flashing of the following characters [8].

The command **\$F1↓** activates the flashing of the entire display [33]. The command **\$F0↓** deactivates the flashing of the entire display [34].

Flashing of the entire display can also be activated with an H-signal at function input F2 (priority over commands).

Marquee text

Marquee text display is activated from the current position in the text with the **\$x** command [9]. It remains active up to the end of the text or a forced line break (**\$C**).

If a seven pixel-high font is currently selected, e.g. Acala 7, marquee text activation only affects the current line.

Character set

The texts are displayed with the character set specified in menu item 22 as standard. To call up another character set, one of the **\$M1** to **\$M9** commands must be contained in the text [10 – 15].

Using commands **\$M1** to **\$M4** the permanently installed character sets of Acala 7 [10], Acala 7 extended [11], Acala 14 condensed [12] and Acala 7 extended [13] are called up.

A user-defined character set with a character height of seven pixels can be called up with the **\$M5** commands [14]. The Acala 7 P character set is preinstalled here. It can be replaced by a character set created by the user, for example.

A user-defined character set with a character height of 14 or 16 pixels can be called up with the **\$M6** command [15]. The Acala 14 P character set is preinstalled here. The Acala 14 character set is preinstalled here. It can be replaced by a character set created by the user or an optional character set (Acala 14 P, Acala 16 condensed, Acala 16 or Acala 16 extended).

Using commands **\$M7** to **\$M9** the character sets Acala 16 condensed, Acala 16 and Acala 16 extended are called up.

The optional character sets and the PC-Tool 'FontManager' for generating user-defined character sets are included on data carrier. The tool is also used to install the character sets, to save character sets on data carrier and to readout installed character sets.

LED color

Units with switchable LED color display the texts in red by default. For a color change, the command **\$A0** (red), **\$A1** (green) or **\$A2** (orange) must be contained in the text [16...18].

Inserting time/date

The units have a real-time clock with a date and weekday display. The current time, date or parts of them can be inserted into the text with the **\$H...** and **\$D...** commands [20 – 30]. The year can be displayed with four [24, 28] or two [25, 29] digits].

The day of the week is displayed abbreviated to two letters in the language set in menu item 23.

Bar graph

The **\$Gnnnn** command in the data telegram is used for activating the bar graph. [31]. **nnnn** stands for the number luminous columns, i.e. the length of the bar graph and must always be four digits, p. e. **\$G0040**.

Units with switchable LED color can only show the Bar graph in red or green. In bar graph mode they ignore command **\$A2** for the color orange. [18].

Character \$

The command for displaying the character '\$' is **\$\$** [32].

Brightness

The brightness of the display can be reduced with the **\$B1↓** command [36] and reset to normal brightness with the command **\$B0↓** [35].

The brightness of the display can also be reduced with an H-signal on function input F1 (priority over commands).

Reset

To restart the unit use command **\$0↓** [37].

Setting time/date

Setting of the time is done with the command **\$SHhmmss↓** [38] **hh** stands for hours, **mm** for minutes and **ss** for seconds (p. e. **\$SH204515↓** 20:45:15 o'clock).

Setting of the date is done with the command **\$SDddmmyy↓** [39]. **dd** stands for the day, **mm** for the month and **yy** for the year (p. e. **\$SD200804↓** = 20.08.2004).

Setting of the weekday is done with command **\$ SWx↓** [40]. **x** stands for the weekday: 1 = Monday, 2 = Tuesday, 3 = Wednesday, 4 = Thursday, 5 = Friday, 6 = Saturday, 7 = Sunday. The weekday is shown abbreviated with 2 letters in the language set in menu item 23.

The time can also be set in menu items 90...92 und 94...95.

Reading out time/date

The current time can be read out via the serial interface with the command **RH↓** [41] and the current date, including the weekday, with the command **\$RD↓** [42].

Paging

If a text contains more characters than can be shown in the display, it is automatically displayed in paging mode. The page change interval can be set between 3 and 30 seconds in menu item 21.

Initial text

Once the operating voltage has been applied, an LED dot in the upper left-hand corner of the display illuminates to indicate that the unit is ready for operation. If an initial text is to appear in the display instead (e.g. 'System trouble-free'), this text is to be saved in the text memory with text number 0, and displaying of the initial text is to be set in menu item 20.

7 Individual line selection

Application

The activation of the devices as described in chapter "Control" is optimized for applications in which individual texts are shown in the display. Longer texts are written in several lines of the display due to the automatic line break. When the text contains more characters than can be displayed, it will be automatically displayed in paging mode.

The individual line selection is optimized for applications in which several texts independent of one another should be shown in different lines and each line should be considered as an individual display. The lines can be selected individually. The control commands only refer to the activated line. The automatic line break and paging functions are not active.

Commands

The individual line selection is carried out by means of commands according to the following command table. In the description of the commands, the numbers in [] refer to the corresponding lines in the command table.

The commands beginning with **\$Lxx** select an individual line. **xx** is the line number (01, 02, 03, ...).

Commands with **↓** require a telegram ending (<CR>, <LF> or <CR/LF>).

In line [43] **cc . . .** stands for a character chain of any desired content.

In line [45] **c** stands for any desired character.

Commannds for text manipulations

Display dynamic text	\$Lxxcc . . .↓	Send any desired characters	[43]
Display static text	\$Lxx\$Tn↓	Calling up fixed text (n = text number, 1 to 4 digits)	[44]
Insert variables	\$VINnnc↓	Insert the character c in a wildcard for a variable (nnn = wildcard number for the variable, 0...255)	[45]
	\$VC↓	Delete all variables	[46]
Delete text	\$Lxx\$E↓	Delete the text in the line xx	[47]

Commands for text formatting

Place holders for variables	\$VNnnn↓	Insert wildcard for variables (nnn = wildcard number for the variable, 0...255))	[48]
-----------------------------	-----------------	--	------

Commands for display options

Flashing	\$Lxx\$F1↓	Flashing of the entire line xx on	[49]
	\$Lxx\$F0↓	Flashing of the entire line xx off	[50]

For all other device functions the commands described in chapter 7 apply.

Display dynamic text

To display a dynamic text, its characters (**cc...**) are transmitted to the selected line as a data telegram [43]. Any text in the display is deleted when a new text is called up.

Display static text

A static text in the selected line can be loaded using the **\$Lxx\$Tn** command [44]. **n** is the Text number, it can be from one to four digits. Any text in the display is deleted when a new text is called up.

Insert variables

The **\$VNnnn** command is used for selecting wildcards for the variables [48]. They appear blank in the display. A variable corresponds to a character to be displayed. Up to 256 variables can be inserted in a text. **nnn** stands for the a wildcard number for variables (0...255).

Insertion of the variables in the place holders occurs with the **\$VINnnc** command [45]. **c** stands for any desired character. Any number of insert commands can be transmitted via a data telegram.

Deleting text

The **\$Lxx\$E** command is used for deleting a text located in line **xx** [47]. Then a LED point flashes in the top left line.

Flashing

The **\$LxxF1** command activates the flashing of the whole line [49]. The command **\$LxxF0** deactivates the flashing of the whole line. [50].

Line numbers

The lines are counted as shown in the following example for the unit version SX502-420/05/.....

For the character height 50 (e.g. Acala 7) 2 lines are counted per LED matrix.

For the character height 100 mm (e.g. Acala 14) 1 line is counted per LED matrix.

This is also valid if both character heights are used.

++++ Character height 50 mm + + + +	Line 01 (Command \$M1\$L01...)
++++ Character height 50 mm + + + +	Line 02 (Command \$M1\$L02...)
++++ Character height 50 mm + + + +	Line 03 (Command \$M1\$L03...)
++++ Character height 50 mm + + + +	Line 04 (Command \$M1\$L04...)

Character height 100 mm	Line 01 (Command \$M3\$L01...)
Character height 100 mm	Line 02 (Command \$M3\$L02...)

Character height 100 mm	Line 01 (Command \$M3\$L01...)
++++ Character height 50 mm + + + +	Line 03 (Command \$M1\$L03...)
++++ Character height 50 mm + + + +	Line 04 (Command \$M1\$L04...)

++++ Character height 50 mm + + + +	Line 01 (Command \$M1\$L01...)
++++ Character height 50 mm + + + +	Line 02 (Command \$M1\$L02...)
Character height 100 mm	Line 02 (Command \$M3\$L02...)

8 Parameterization



Bus errors may result in personal injury or material damage. Therefore it must be noted that resetting the unit with the command \$0 and activating the menu during the operation of devices on the bus can cause a bus error.

Menu

The parameterization of the devices is carried out in a menu in the menu display.

In normal operation, status messages appear in the menu display.

Menu operation

To start the menu, press both menu buttons simultaneously (approx. 1 sec.) until the first menu item appears in the menu display. It is now possible to navigate in the menu as follows:

Next menu items forward	Press key [↕] long
Page menu items forward	Shortly press key [↕]
Previous menu item	Double-click on key [↕]
Page menu items backward	Double-click on key [↕] and keep it pressed

Next setting	Shortly press key [↔]
Page settings forward	Press key [↔] long
Previous setting	Double-click on key [↔]
Page setting backward	Double-click on key [↔] and keep it pressed

To exit the menu shortly press the key [↕] in menu item 99. Depending on the setting in menu item 99 the settings made are either saved (set) or not saved (escape) or the factory settings are reset (default).

Canceling the menu without saving the settings made is possible by pressing both menu buttons simultaneously (approx. 1 sec.). It will occur automatically if 60 seconds pass without a menu button being pressed.

Once the menu is closed, the device behaves in the same manner as when the operating voltage was applied.

Menu table

The menu items are displayed in the following menu table. The factory settings are marked with an *. Individual menu items or settings can be suppressed in another menu item, depending on the unit version or setting.

Menu item	Settings	Menu display
01 Serial interface	RS232	01 232
	RS485	01 485
	RS485 (4-wire bus)	01 4854
	RS485 (2-wire bus)	01 4852
	RS232 Programming operation	01 PrOG
02 Data format	8 bit*	02 8bit
03 Parity	No parity*	03 nonE
	Odd parity	03 odd
	Even parity	03 EvEn
04 Baud rate	1200	04 1200
	2400	04 2400
	4800	04 4800
	9600*	04 9600
	19200	04 192
	38400	04 384
05 Protocol	CR/LF*	05 crLF
	STX/ETX	05 S-E
06 Protocol reply	No protocol reply*	06 nonE
	ACK/NAK	06 RcnR
07 Handshake	No Handshake*	07 nonE
	XON/XOFF-Handshake	07 onnF
08 Address length	No addressing*	08 0
	1 digit	08 1
	2 digits	08 2
	3 digits	08 3
09 Address	Address 0*	09 000
	Address 1	09 001
	↓ Address 999	↓ 09 999
10 Time-out	No time-out*	10 0
	Time-out after 1 s	10 1
	↓ Time-out after 3600 s	↓ 10 3600
20 Initial text	No display of initial text*	20 OFF
	Display initial text	20 On
21 Paging	3 Seconds*	21 3
	↓	↓

		30 Seconds	21	30
22	Character set	Acala 7*	22	7
		Acala 7 extended	22	7E
		Acala 14 condensed	22	14C
		Acala 14 extended	22	14E
		Acala 7 P / user-defined character set 7 pixel	22	U1
		Acala 14 / user-defined character set 14/16 pixel	22	U2
		Acala 16 condensed	22	16C
		Acala 16	22	16
		Acala 16 extended	22	16E
23	Language	German*	23	G
		French	23	F
		English	23	E
24	Display test	No display test at power-on	24	OFF
		Display test at power-on	24	On
90	Setting date (year)	00	90	00
		↓	↓	
		99	90	99
91	Setting date (month)	1	91	1
		↓	↓	
		12	91	12
92	Setting date (day)	1	92	1
		↓	↓	
		31	92	31
94	Setting time (hours)	1	94	0
		↓	↓	
		23	94	23
95	Setting time (minutes)	0	95	0
		↓	↓	
		59	95	59
99	Save	Save parameters* (Set)	99	SEt
		Not saving paramerts (Escape)	99	ESC
		Restore to factory settings (Default)	99	dEF

Time-out

In menu item 10 it is possible to set whether a time-out occurs and if so after what time. Time-out means that the display is cleared if it has not received a data telegram after a defined time period. An LED dot then illuminates in the upper left-hand corner of the display.

Initial text

Once the operating voltage has been applied, an info text appears in the display showing the unit type. If an initial text is to appear in the display instead (e.g. 'System trouble-free'), this text is to be saved in the text memory with text number 0, and displaying of the initial text is to be set in menu item 20.

If in menu item 24 a display test is selected this one will appear on the display before the start text.

Paging

If a text contains more characters than can be shown in the display, it is automatically displayed in paging mode. The page change interval can be set between 3 and 30 seconds in menu item 21.

Character set

In menu item 22, you can set the default character set used to display the texts. Character sets Acala 7, Acala 7 extended, Acala 14 condensed and Acala 14 extended are permanently installed in the units. Also the character sets Acala 16, Acala 16 condensed und Acala 16 extended.

The character set Acala 7 P can be loaded with the setting $\overline{U} \overline{I}$. It can be replaced by a user-defined character set with a character height of up to 7 pixels.

The character set Acala 14P can be loaded with the setting $\overline{U} \overline{Z}$. It can be replaced by a user-defined character set with a character height of up to 16 pixels or by an optional character set (Acala 14 P, Acala 16 condensed, Acala 16 or Acala 16 extended).

The optional character sets and the PC tool 'FontManager' for creating user-defined character sets are delivered on a data carrier. The tool is also used to install character sets, to save character sets to data media and to read back installed character sets.

Language

In menu item 23, you can set the language in which the weekday is displayed (abbreviated to two letters).

Display test

In menu item 24, you can set whether a display test is to be performed after the operating voltage is applied.

The test ends with the first data telegram, after the time out set in menu item 10, or if a start text is to be displayed.

Network parameters

The network parameters are set with the software tool "Gateway IPconfig setup.exe" included in delivery.

Take note of the extra documentation on the product CD.

Set time/date

The year, month, and day of the real-time clock are set in menu items 90 – 93. The time at which the clock is to be started is set in menu items 94 – 95. Then select menu item 99 and select the setting \overline{SEI} there. When the set time is reached, briefly press the left menu button [\uparrow]. The clock is now set to the current time.

If the settings in menu items 90 – 93 (date) and 94 – 95 (time) are not changed when the menu is run through, the current settings for the time, date and weekday are retained when the menu is exited. Therefore, the clock only needs to be set when running through the menu if this is intended.

Time and date can be set independently from one another.

Setting the clock can also occur with control commands via the Ethernet interface.

Attention: Setting unrealistic date values, e.g. 31/02/06 can lead to unpredictable date displays and is therefore impermissible.

9 Status messages

Fault messages

Serious faults due to improper operation or faulty operating conditions are indicated in the display. The following messages are possible:

Fault message	Cause	Rectification
No Text	The called up text is not available in the text memory.	The text is to be loaded into the text memory
Syntax Error/Failure	An incorrect command was sent to the display.	The command has to be corrected (see command table).

10 Character table

	<NUL>	64	@	128	€	192	Α
1	☺	65	A	129	ü	193	Β
2	<STX>	66	B	130	é	194	В
3	<ETX>	67	C	131	â	195	Γ
4	<EOT>	68	D	132	ä	196	Д
5	♣	69	E	133	à	197	Е
6	<ACK>	70	F	134	á	198	Ж
7	<BEL>	71	G	135	ç	199	З
8	<BS>	72	H	136	ê	200	И
9	<HT>	73	I	137	ë	201	Й
10	<LF>	74	J	138	è	202	К
11	♂	75	K	139	ï	203	Л
12	♀	76	L	140	î	204	М
13	<CR>	77	M	141	ì	205	Н
14	♪	78	N	142	À	206	О
15	*	79	O	143	Á	207	П
16	<DLE>	80	P	144	Ě	208	Р
17	<XON>	81	Q	145	æ	209	С
18	↕	82	R	146	Æ	210	Т
19	<XOFF>	83	S	147	ô	211	У
20	¶	84	T	148	ö	212	Ф
21	<NAK>	85	U	149	ò	213	Х
22	■	86	V	150	ù	214	Ц
23	↓	87	W	151	û	215	Ч
24	↑	88	X	152	ÿ	216	Ш
25	↓	89	Y	153	Ŏ	217	Щ
26	<EOF>	90	Z	154	Ū	218	Ъ
27	<ESC>	91	[155	ø	219	Ы
28	↳	92	\	156	£	220	Ь
29	↔	93]	157	∅	221	Э
30	▲	94	^	158	x	222	Ю
31	▼	95	_	159	f	223	Я
32	<SPACE>	96	`	160	á	224	α
33	!	97	a	161	í	225	β
34	"	98	b	162	ó	226	Γ
35	#	99	c	163	ú	227	Π
36	\$	100	d	164	ñ	228	Σ
37	%	101	e	165	Ñ	229	σ
38	&	102	f	166	ª	230	μ
39	'	103	g	167	ǒ	231	τ
40	(104	h	168	reserved	232	Φ
41)	105	i	169	┌	233	Θ
42	*	106	j	170	└	234	Ω
43	+	107	k	171	½	235	δ
44	,	108	l	172	¼	236	∞
45	-	109	m	173	ı	237	φ
46	.	110	n	174	«	238	ε
47	/	111	o	175	»	239	∩
48	0	112	p	176	▒	240	≡
49	1	113	q	177	▒	241	±
50	2	114	r	178	▒	242	≥
51	3	115	s	179	reserved	243	≤
52	4	116	t	180	reserved	244	reserved
53	5	117	u	181	reserved	245	reserved
54	6	118	v	182	reserved	246	÷
55	7	119	w	183	reserved	247	≈
56	8	120	x	184	reserved	248	°
57	9	121	y	185	reserved	249	·
58	:	122	z	186	reserved	250	·
59	;	123	{	187	Pt	251	√
60	<	124		188	≡	252	ⁿ
61	=	125	}	189	¢	253	²
62	>	126	~	190	¥	254	■
63	?	127	△	191	Ě	255	ρ

11 Technical data

Unit properties

The model designation is structured as follows:

SX502		-	[] [] []	/	[] [] []	/	[] [] []	-	[] [] [] []	/	[] [] []	-	[] [] []
2 lines	2	:	:	:	:	:	:	:	:	:	:	:	:
4 lines	4	:	:	:	:	:	:	:	:	:	:	:	:
6 lines	6	:	:	:	:	:	:	:	:	:	:	:	:
8 lines	8	:	:	:	:	:	:	:	:	:	:	:	:
20 characters/line*	2 0	:	:	:	:	:	:	:	:	:	:	:	:
40 characters/line*	4 0	:	:	:	:	:	:	:	:	:	:	:	:
Character height 33/66/75 mm	0 3	:	:	:	:	:	:	:	:	:	:	:	:
Character height 50/100/120 mm	0 5	:	:	:	:	:	:	:	:	:	:	:	:
LED Standard	0	:	:	:	:	:	:	:	:	:	:	:	:
LED for outdoor use	2	:	:	:	:	:	:	:	:	:	:	:	:
LED color red	R	:	:	:	:	:	:	:	:	:	:	:	:
LED color red/green/orange switchable	M	:	:	:	:	:	:	:	:	:	:	:	:
Display readable on one side	1	:	:	:	:	:	:	:	:	:	:	:	:
Display readable on both sides	2	:	:	:	:	:	:	:	:	:	:	:	:
Steel sheet housing, coated	0	:	:	:	:	:	:	:	:	:	:	:	:
Steel sheet housing, bilayer painting	1	:	:	:	:	:	:	:	:	:	:	:	:
Stainless steel housing V2A, coated	2	:	:	:	:	:	:	:	:	:	:	:	:
Stainless steel housing V2A, brushed	3	:	:	:	:	:	:	:	:	:	:	:	:
Stainless steel housing V4A, brushed	5	:	:	:	:	:	:	:	:	:	:	:	:
Protection type IP54	0	:	:	:	:	:	:	:	:	:	:	:	:
Protection type IP65	1	:	:	:	:	:	:	:	:	:	:	:	:
Protection type IP54 with climate adjustment	2	:	:	:	:	:	:	:	:	:	:	:	:
Protection type IP54 with climate adjustment and heating	4	:	:	:	:	:	:	:	:	:	:	:	:
Wall mounting, cable entry point from the bottom	0	:	:	:	:	:	:	:	:	:	:	:	:
Wall mounting, cable entry point from the top	1	:	:	:	:	:	:	:	:	:	:	:	:
Hanging installation, cable entry point from the bottom	2	:	:	:	:	:	:	:	:	:	:	:	:
Hanging installation, cable entry point from the top	3	:	:	:	:	:	:	:	:	:	:	:	:
Wall mounting and hanging installation, cable entry point from the bottom	4	:	:	:	:	:	:	:	:	:	:	:	:
Wall mounting and hanging installation, cable entry point from the top	5	:	:	:	:	:	:	:	:	:	:	:	:
Power supply 230 V AC ±15 %, 50 Hz	A	:	:	:	:	:	:	:	:	:	:	:	:
Power supply 24 V DC ±15 %	B	:	:	:	:	:	:	:	:	:	:	:	:
Power supply 115 V AC ±15 %, 60 Hz	C	:	:	:	:	:	:	:	:	:	:	:	:
Interface		:	:	:	:	:	:	:	:	:	:	x	x

* applies for Acala 7 character set

Housing colors

Case front	RAL 5002 ultramarine
Case rear part	RAL 7035 light grey

Front frame

SX502-xxx/xx/xR-xxx/xx-xx	plastic, tinted red, non-reflective
SX502-xxx/xx/xM-xxx/xx-xx	plastic, clear, non-reflective

Ambient conditions

Operating temperature	0...40 °C
Storage temperature	-30...85 °C
Relative humidity	max. 95 % (non-condensing)

Max. power consumption

Units with character height of 33/66/75 mm

One-sided display		Double-sided display	
SX502-220/03/0R-1xx/xx-xx	approx. 40 VA	SX502-220/03/0R-2xx/xx-xx	approx. 75 VA
SX502-220/03/0M-1xx/xx-xx	approx. 65 VA	SX502-220/03/0M-2xx/xx-xx	approx. 130 VA
SX502-420/03/0R-1xx/xx-xx	approx. 75 VA	SX502-420/03/0R-2xx/xx-xx	approx. 140 VA
SX502-420/03/0M-1xx/xx-xx	approx. 130 VA	SX502-420/03/0M-2xx/xx-xx	approx. 265 VA
SX502-620/03/0R-1xx/xx-xx	approx. 105 VA	SX502-620/03/0R-2xx/xx-xx	approx. 220 VA
SX502-620/03/0M-1xx/xx-xx	approx. 205 VA	SX502-620/03/0M-2xx/xx-xx	approx. 390 VA
SX502-820/03/0R-1xx/xx-xx	approx. 140 VA	SX502-820/03/0R-2xx/xx-xx	approx. 290 VA
SX502-820/03/0M-1xx/xx-xx	approx. 265 VA	SX502-820/03/0M-2xx/xx-xx	approx. 525 VA
SX502-240/03/0R-1xx/xx-xx	approx. 75 VA	SX502-240/03/0R-2xx/xx-xx	approx. 150 VA
SX502-240/03/0M-1xx/xx-xx	approx. 130 VA	SX502-240/03/0M-2xx/xx-xx	approx. 265 VA
SX502-440/03/0R-1xx/xx-xx	approx. 140 VA	SX502-440/03/0R-2xx/xx-xx	approx. 290 VA
SX502-440/03/0M-1xx/xx-xx	approx. 265 VA	SX502-440/03/0M-2xx/xx-xx	approx. 525 VA
SX502-640/03/0R-1xx/xx-xx	approx. 210 VA	SX502-640/03/0R-2xx/xx-xx	approx. 425 VA
SX502-640/03/0M-1xx/xx-xx	approx. 390 VA	SX502-640/03/0M-2xx/xx-xx	approx. 775 VA
SX502-840/03/0R-1xx/xx-xx	approx. 280 VA	SX502-840/03/0R-2xx/xx-xx	approx. 560 VA
SX502-840/03/0M-1xx/xx-xx	approx. 515 VA	SX502-840/03/0M-2xx/xx-xx	approx. 1010 VA

Units with character height 50/100/120 mm

One-sided display		Double-sided display	
SX502-220/05/0R-1xx/xx-xx	approx. 45 VA	SX502-220/05/0R-2xx/xx-xx	approx. 85 VA
SX502-220/05/0M-1xx/xx-xx	approx. 85 VA	SX502-220/05/0M-2xx/xx-xx	approx. 165 VA
SX502-420/05/0R-1xx/xx-xx	approx. 85 VA	SX502-420/05/0R-2xx/xx-xx	approx. 170 VA
SX502-420/05/0M-1xx/xx-xx	approx. 165 VA	SX502-420/05/0M-2xx/xx-xx	approx. 335 VA
SX502-620/05/0R-1xx/xx-xx	approx. 130 VA	SX502-620/05/0R-2xx/xx-xx	approx. 250 VA
SX502-620/05/0M-1xx/xx-xx	approx. 245 VA	SX502-620/05/0M-2xx/xx-xx	approx. 490 VA
SX502-820/05/0R-1xx/xx-xx	approx. 170 VA	SX502-820/05/0R-2xx/xx-xx	approx. 335 VA
SX502-820/05/0M-1xx/xx-xx	approx. 335 VA	SX502-820/05/0M-2xx/xx-xx	approx. 660 VA
SX502-240/05/0R-1xx/xx-xx	approx. 85 VA	SX502-240/05/0R-2xx/xx-xx	approx. 170 VA
SX502-240/05/0M-1xx/xx-xx	approx. 165 VA	SX502-240/05/0M-2xx/xx-xx	approx. 320 VA
SX502-440/05/0R-1xx/xx-xx	approx. 170 VA	SX502-440/05/0R-2xx/xx-xx	approx. 335 VA
SX502-440/05/0M-1xx/xx-xx	approx. 320 VA	SX502-440/05/0M-2xx/xx-xx	approx. 650 VA
SX502-640/05/0R-1xx/xx-xx	approx. 250 VA	SX502-640/05/0R-2xx/xx-xx	approx. 500 VA
SX502-640/05/0M-1xx/xx-xx	approx. 490 VA	SX502-640/05/0M-2xx/xx-xx	approx. 980 VA
SX502-840/05/0R-1xx/xx-xx	approx. 335 VA	SX502-840/05/0R-2xx/xx-xx	approx. 685 VA
SX502-840/05/0M-1xx/xx-xx	approx. 650 VA	SX502-840/05/0M-2xx/xx-xx	approx. 1295 VA

The power consumption for the type SX502-xx/xx/0x-xxx/xx-xx is also valid for the type SX502-xx/xx/2x-xxx/xx-xx (LEDs for external use).

For units with built-in heating, the values for power consumption specified in the table increase by approx. 10 – 200 VA (exact values on request), depending on the unit size.

Screw-type terminals

Control computer	Capacity of terminals 0,14...1,5 mm ²
Power supply	Capacity of terminals 0,2...4 mm ²

Fixed text memory

Capacity	128 KBytes
Number of texts	max. 10.000
Text length	max. 2048 characters (for individual line selection, the number is divided by the number of lines).

Marquee

Text length	max. 4000 display columns (pixel)
-------------	-----------------------------------

Real-time clock

Precision	20 ppm
-----------	--------

Dimensions and weights

Units with character height of 33/66/75 mm and one-sided display

The following figure shows unit version SX502-640/03/0x-1xx/xx-xx, representing the other unit versions listed in the following table. All dimensions are in mm.

LG1, LG2 and LG3 are ventilation grates on units ventilated by other means. The ventilation grates and their arrangement are not pictured to scale. The following table specifies the ventilation grates of the individual unit versions.

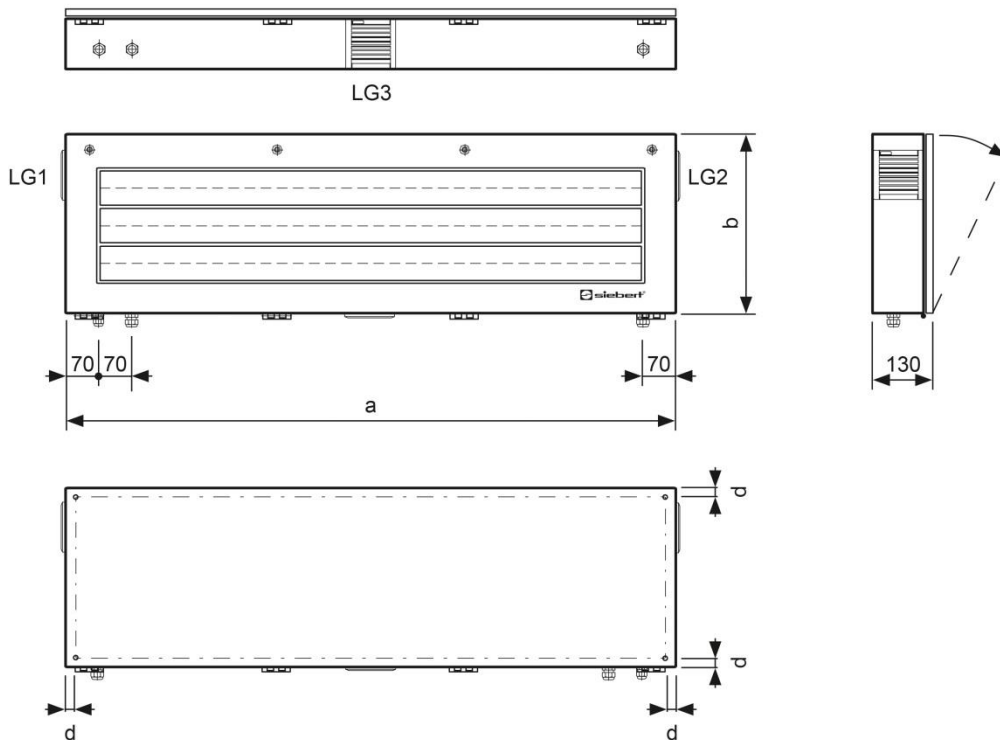

Unit version	a	b	d	Ø	LG1	LG2	LG3	Weight
SX502-220/03/0R-1xx/xx-xx	700	210	16	7	–	–	–	approx. 12 kg
SX502-220/03/0M-1xx/xx-xx	700	210	16	7	–	–	–	approx. 12 kg
SX502-420/03/0R-1xx/xx-xx	700	300	16	7	–	–	–	approx. 14 kg
SX502-420/03/0M-1xx/xx-xx	700	300	16	7	–	–	–	approx. 14 kg
SX502-620/03/0R-1xx/xx-xx	700	380	20	9	–	–	–	approx. 18 kg
SX502-620/03/0M-1xx/xx-xx	700	380	20	9	■	■	–	approx. 18 kg
SX502-820/03/0R-1xx/xx-xx	720	490	20	9	–	–	–	approx. 21 kg
SX502-820/03/0M-1xx/xx-xx	720	490	20	9	■	■	–	approx. 21 kg
SX502-240/03/0R-1xx/xx-xx	1270	210	20	9	–	–	–	approx. 18 kg
SX502-240/03/0M-1xx/xx-xx	1270	210	20	9	–	–	–	approx. 18 kg
SX502-440/03/0R-1xx/xx-xx	1270	300	20	9	–	–	–	approx. 22 kg
SX502-440/03/0M-1xx/xx-xx	1270	300	20	9	■	■	■	approx. 22 kg
SX502-640/03/0R-1xx/xx-xx	1270	380	20	9	–	–	–	approx. 28 kg
SX502-640/03/0M-1xx/xx-xx	1270	380	20	9	■	■	■	approx. 28 kg
SX502-840/03/0R-1xx/xx-xx	1290	490	20	9	–	–	–	approx. 34 kg
SX502-840/03/0M-1xx/xx-xx	1290	490	20	9	■	■	■	approx. 34 kg

Units with character height of 33/66/75 mm and double-sided display

The following figure shows unit version SX502-640/03/0x-2xx/xx-xx, representing the other unit versions listed in the following table. All dimensions are in mm.

LG1, LG2, LG3 and LG4 are ventilation grates on units ventilated by other means. The ventilation grates and their arrangement are not pictured to scale. The following table specifies the ventilation grates of the individual unit versions.

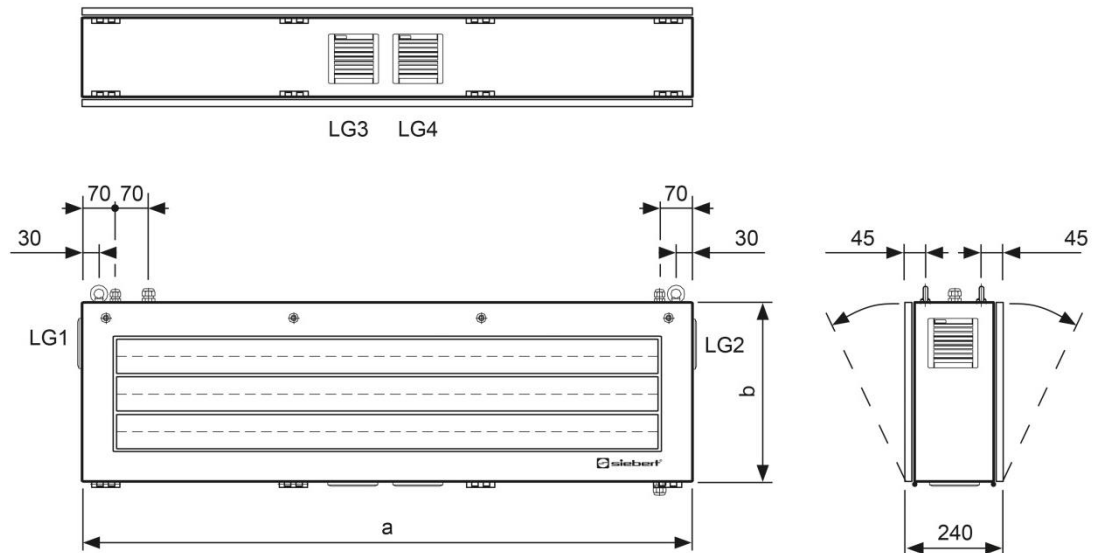

Unit version	a	b	LG1	LG2	LG3	LG4	Weight
SX502-220/03/0R-2xx/xx-xx	700	210	–	–	–	–	approx. 17 kg
SX502-220/03/0M-2xx/xx-xx	700	210	–	–	–	–	approx. 17 kg
SX502-420/03/0R-2xx/xx-xx	700	300	–	–	–	–	approx. 22 kg
SX502-420/03/0M-2xx/xx-xx	700	300	■	–	–	■	approx. 22 kg
SX502-620/03/0R-2xx/xx-xx	700	380	■	–	–	■	approx. 28 kg
SX502-620/03/0M-2xx/xx-xx	700	380	■	–	–	■	approx. 28 kg
SX502-820/03/0R-2xx/xx-xx	720	490	■	–	–	■	approx. 32 kg
SX502-820/03/0M-2xx/xx-xx	720	490	■	■	■	■	approx. 32 kg
SX502-240/03/0R-2xx/xx-xx	1270	210	–	–	–	–	approx. 26 kg
SX502-240/03/0M-2xx/xx-xx	1270	210	■	■	–	–	approx. 26 kg
SX502-440/03/0R-2xx/xx-xx	1270	300	■	–	–	■	approx. 34 kg
SX502-440/03/0M-2xx/xx-xx	1270	300	■	■	■	■	approx. 34 kg
SX502-640/03/0R-2xx/xx-xx	1270	380	■	–	–	■	approx. 42 kg
SX502-640/03/0M-2xx/xx-xx	1270	380	■	■	■	■	approx. 42 kg
SX502-840/03/0R-2xx/xx-xx	1290	490	■	■	■	–	approx. 50 kg
SX502-840/03/0M-2xx/xx-xx	1290	490	■	■	■	■	approx. 50 kg

Units with character height of 50/100/120 mm and one-sided display

The following figure shows unit version SX502-820/05/0x-1xx/xx-xx, representing the other unit versions listed in the following table. All dimensions are in mm.

LG1 and LG2 are ventilation grates on units ventilated by other means. The ventilation grates and their arrangement are not pictured to scale. The following table specifies the ventilation grates of the individual unit versions.

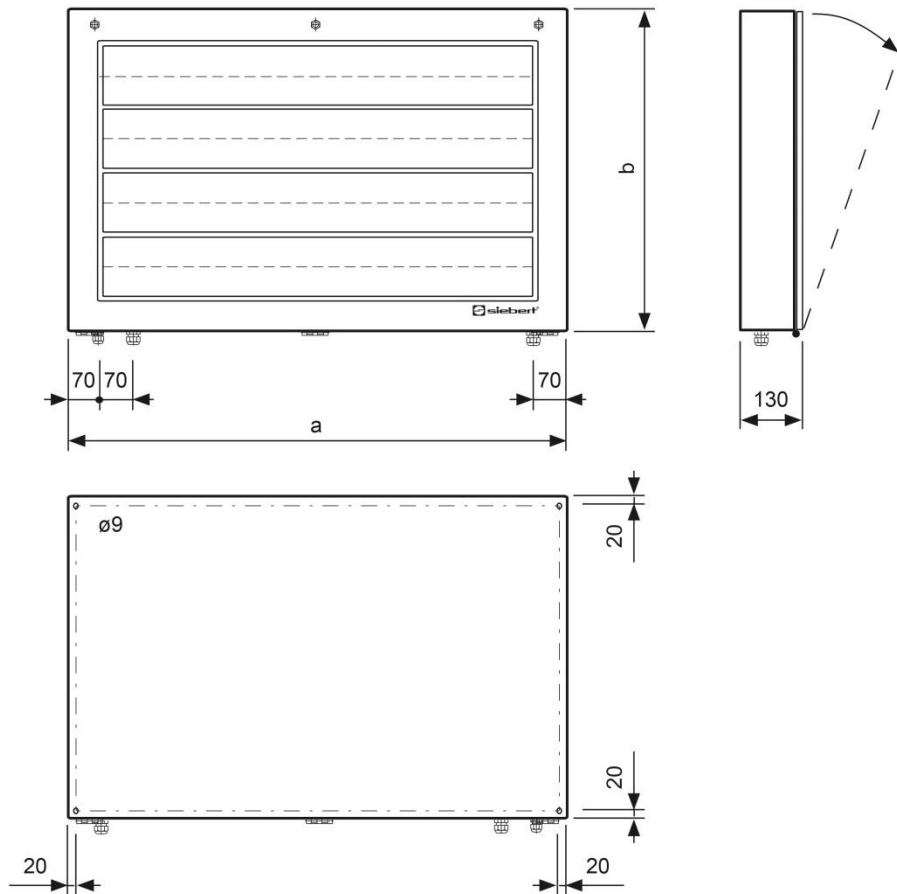

Unit version	a	b	LG1	LG2	Weight
SX502-220/05/0R-1xx/xx-xx	1040	250	–	–	approx. 16 kg
SX502-220/05/0M-1xx/xx-xx	1040	250	–	–	approx. 16 kg
SX502-420/05/0R-1xx/xx-xx	1040	390	–	–	approx. 22 kg
SX502-420/05/0M-1xx/xx-xx	1040	390	–	–	approx. 22 kg
SX502-620/05/0R-1xx/xx-xx	1040	530	–	–	approx. 28 kg
SX502-620/05/0M-1xx/xx-xx	1040	530	–	–	approx. 28 kg
SX502-820/05/0R-1xx/xx-xx	1060	680	–	–	approx. 35 kg
SX502-820/05/0M-1xx/xx-xx	1060	680	–	–	approx. 35 kg
SX502-240/05/0R-1xx/xx-xx	1960	250	–	–	approx. 27 kg
SX502-240/05/0M-1xx/xx-xx	1960	250	–	–	approx. 27 kg
SX502-440/05/0R-1xx/xx-xx	1960	390	–	–	approx. 40 kg
SX502-440/05/0M-1xx/xx-xx	1960	390	–	–	approx. 40 kg

The following figure shows unit version SX502-640/05/0x-1xx/xx-xx, representing the other unit versions listed in the following table. All dimensions are in mm.

LG1, LG2 and LG3 are ventilation grates on units ventilated by other means. The ventilation grates and their arrangement are not pictured to scale. The following table specifies the ventilation grates of the individual unit versions.

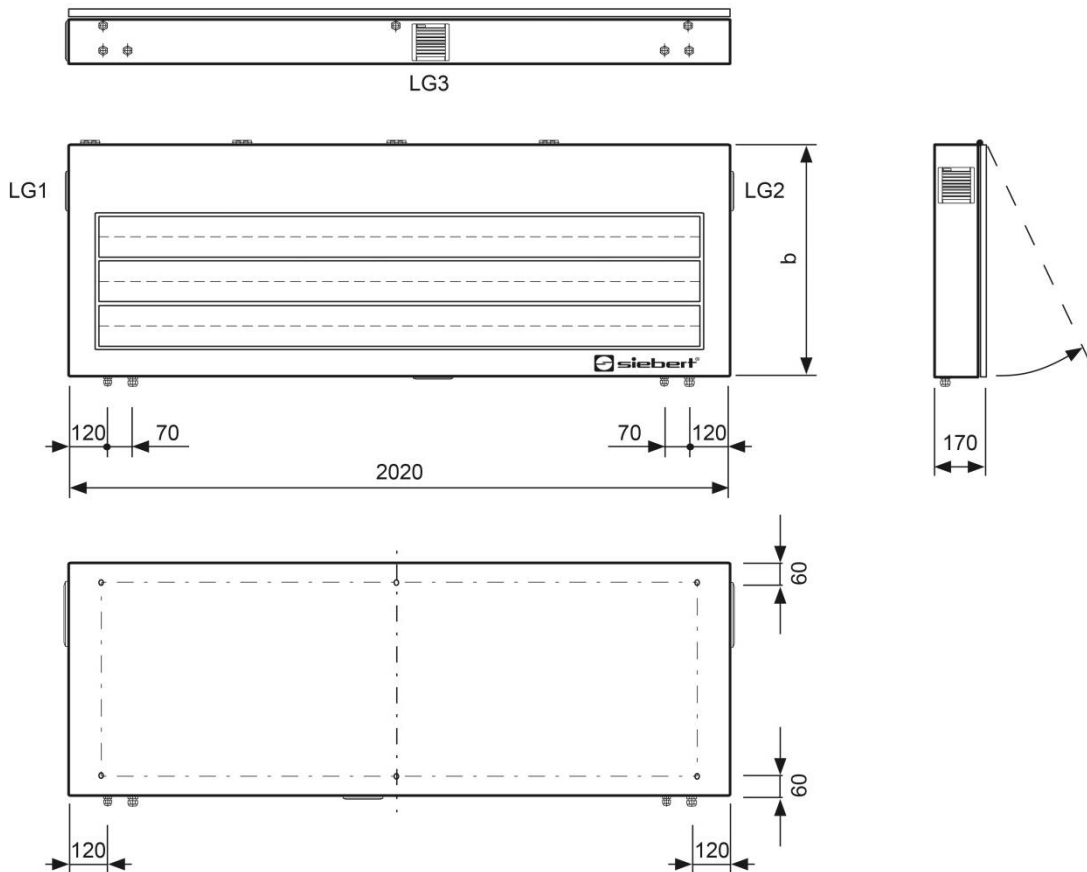

Unit version	b	LG1	LG2	LG3	Weight
SX502-640/05/0R-1xx/xx-xx	710	–	–	–	approx. 82 kg
SX502-640/05/0M-1xx/xx-xx	710	■	■	■	approx. 82 kg
SX502-840/05/0R-1xx/xx-xx	850	–	–	–	approx. 96 kg
SX502-840/05/0M-1xx/xx-xx	850	■	■	■	approx. 96 kg

Units with character height of 50/100/120 mm and double-sided display

The following figure shows unit version SX502-820/05/0x-2xx/xx-xx, representing the other unit versions listed in the following table. All dimensions are in mm.

LG1, LG2, LG3 and LG4 are ventilation grates on units ventilated by other means. The ventilation grates and their arrangement are not pictured to scale. The following table specifies the ventilation grates of the individual unit versions.

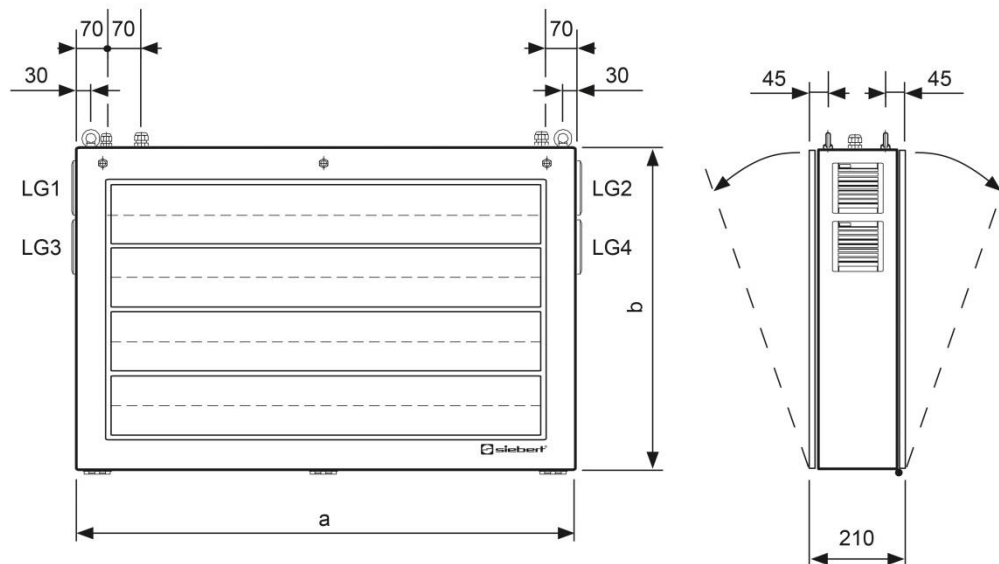

Unit version	a	b	LG1	LG2	LG3	LG4	Weight
SX502-220/05/0R-2xx/xx-xx	1040	250	–	–	–	–	approx. 24 kg
SX502-220/05/0M-2xx/xx-xx	1040	250	–	–	–	–	approx. 24 kg
SX502-420/05/0R-2xx/xx-xx	1040	390	–	–	–	–	approx. 38 kg
SX502-420/05/0M-2xx/xx-xx	1040	390	–	–	–	–	approx. 38 kg
SX502-620/05/0R-2xx/xx-xx	1040	530	–	–	–	–	approx. 47 kg
SX502-620/05/0M-2xx/xx-xx	1040	530	■	■	–	–	approx. 47 kg
SX502-820/05/0R-2xx/xx-xx	1060	680	–	–	–	–	approx. 65 kg
SX502-820/05/0M-2xx/xx-xx	1060	680	■	■	■	■	approx. 65 kg

The following figure shows unit version SX502-440/05/0x-2xx/xx-xx, representing the other unit versions listed in the following table. All dimensions are in mm.

LG1, LG2 and LG3 are ventilation grates on units ventilated by other means. The ventilation grates and their arrangement are not pictured to scale. The following table specifies the ventilation grates of the individual unit versions.

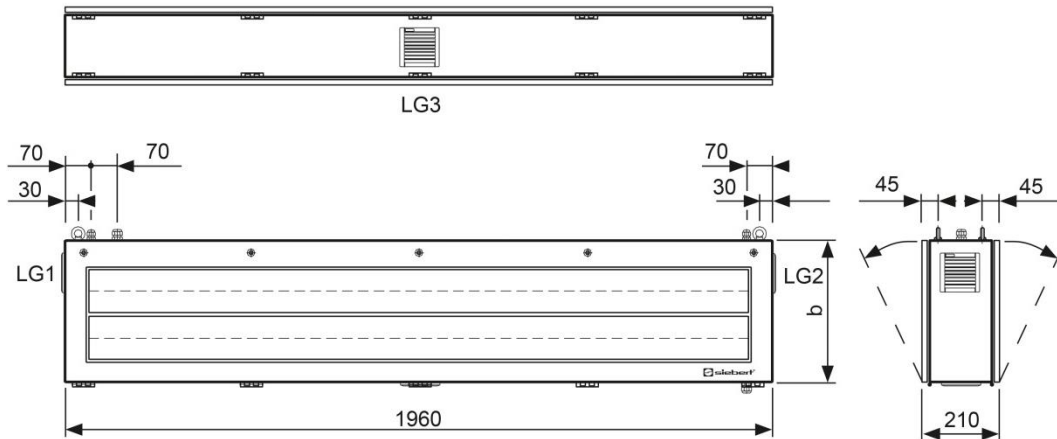

Unit version	b	LG1	LG2	LG3	Weight
SX502-240/05/0R-2xx/xx-xx	250	–	–	–	approx. 45 kg
SX502-240/05/0M-2xx/xx-xx	250	–	–	–	approx. 45 kg
SX502-440/05/0R-2xx/xx-xx	390	–	–	–	approx. 66 kg
SX502-440/05/0M-2xx/xx-xx	390	■	■	■	approx. 66 kg

The following figure shows unit version SX502-840/05/0x-2xx/xx-xx, representing the other unit versions listed in the following table. All dimensions are in mm.

LG1, LG2, LG3 and LG4 are ventilation grates on units ventilated by other means. The ventilation grates and their arrangement are not pictured to scale. The following table specifies the ventilation grates of the individual unit versions.

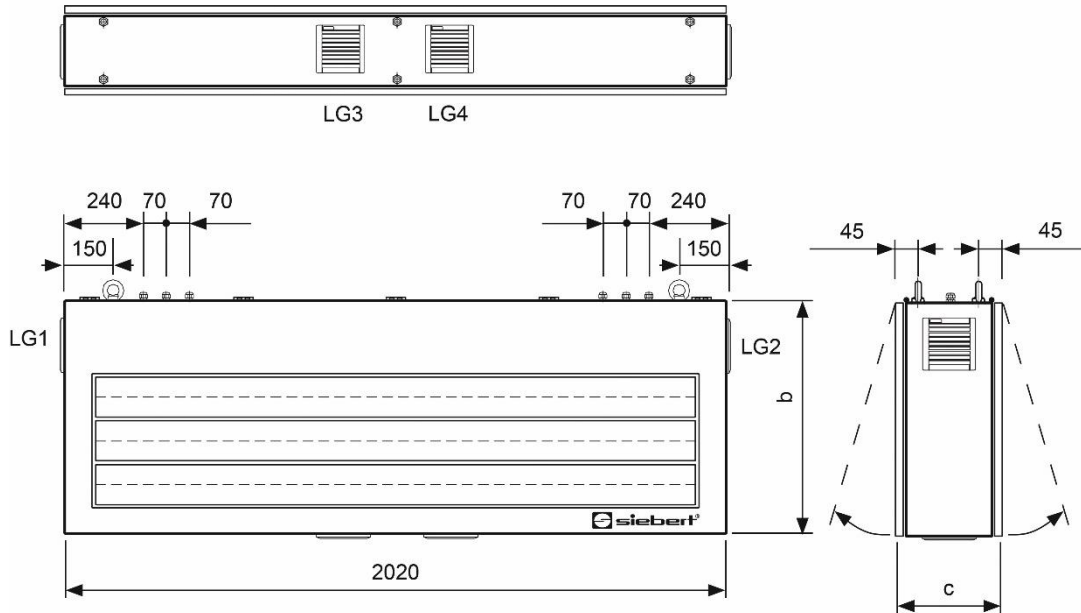

Unit version	b	c	LG1	LG2	LG3	LG4	Weight
SX502-640/05/0R-2xx/xx-xx	710	270	–	–	–	–	approx. 136 kg
SX502-640/05/0M-2xx/xx-xx	710	270	■	■	■	■	approx. 136 kg
SX502-840/05/0R-2xx/xx-xx	850	300	■	■	–	■	approx. 160 kg
SX502-840/05/0M-2xx/xx-xx	850	300	■	■	■	■	approx. 160 kg